

R-S-T : 3 PHASE 3x220V  
 RA : DOOR OPEN CONTACTOR (220V AC)  
 RK : DOOR CLOSE CONTACTOR (220V AC)  
 RAY : AUXILIARY RELAY OF DOOR OPEN CONTACTOR (24V DC)  
 RKY : AUXILIARY RELAY OF DOOR CLOSE CONTACTOR (24V DC)  
 AL : DOOR OPEN LIMIT  
 KL : DOOR CLOSE LIMIT

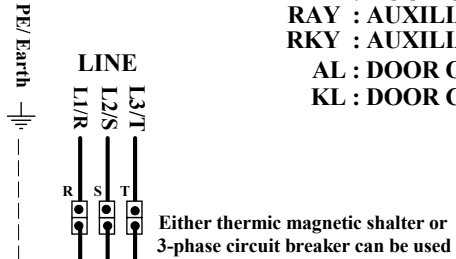

Either thermic magnetic shalter or 3-phase circuit breaker can be used

Thermic Magnetic Switch

VARISTOR

RC filter must be used when contactor coil voltage 220V AC.

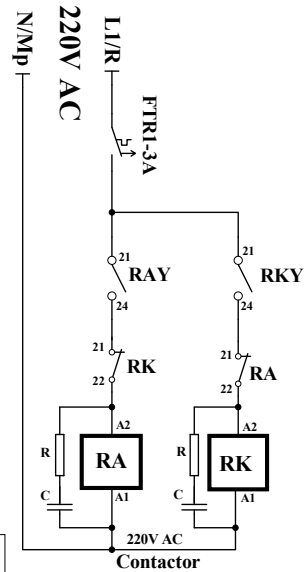

220V AC

Contactor

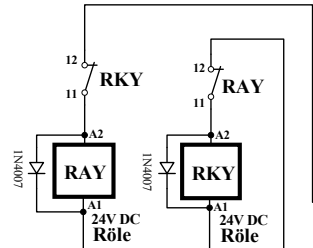

IN4007

IN4007

A1 24V DC Rôle

A1 24V DC Rôle

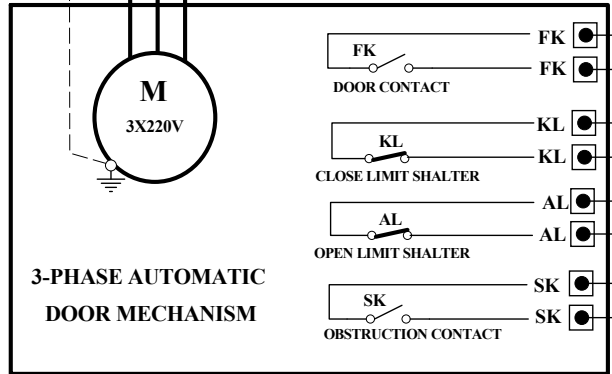

3-PHASE AUTOMATIC DOOR MECHANISM

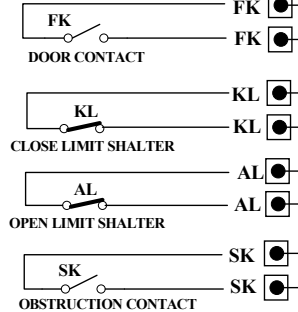

PHOTOCELL

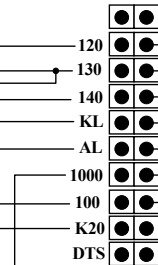

LANDING DOOR CONTACTS

LANDING DOOR CONTACTS

Earth

\*\*KSF1, KSF2 : EN 60947-4-1 AC3 Type Contactors

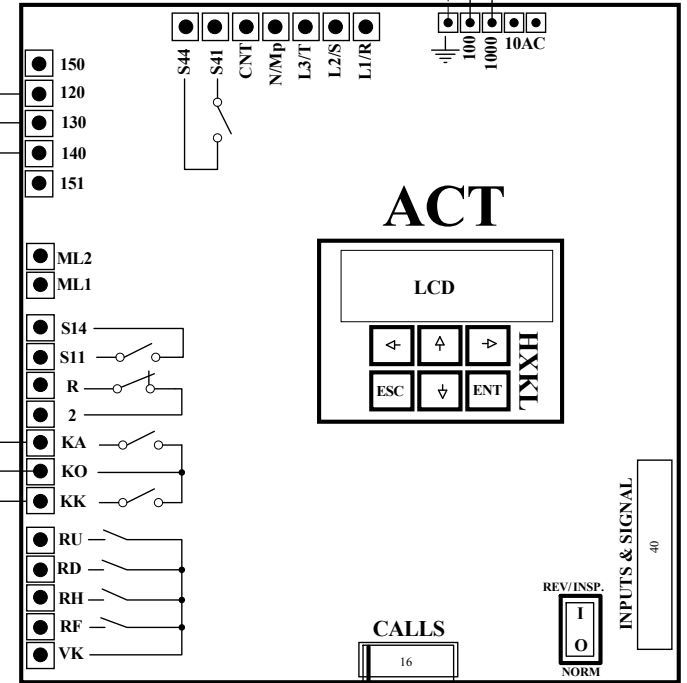

ACT

LCD

H X K L

CALLS

PIC Kartna

REV/INSP. I O NORM

INPUTS & SIGNAL 40

F/7.5.02.69

This document is a sample for applications. All information contained in these materials are subject to change by Aybey Elektronik without notice. Aybey Elektronik assumes no responsibility for any damage, liability, or other loss rising from these inaccuracies or errors.

3-PHASE DOOR CONNECTIONS				
AYBEY ELEKTRONIK	SERIES	ACT	DRW.	A.POLAT
	PROJ.	ACT020	APPRV.	M. AYBEY
	REV.	00	DATE	01 DEC 11