

CFU-CDH VE CCV KARTLARI KAT AYARLARI

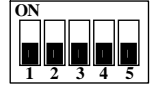

KAT 0



KAT 1



KAT 2



KAT 3



KAT 4

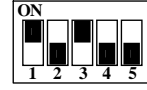

KAT 5



KAT 6



KAT 7



KAT 8



KAT 9



KAT 10



KAT 11



KAT 12



KAT 13



KAT 14



KAT 15

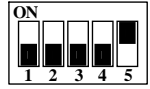

KAT 16

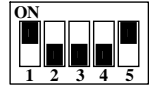

KAT 17



KAT 18



KAT 19



KAT 20

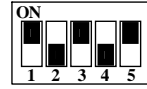

KAT 21



KAT 22

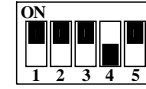

KAT 23

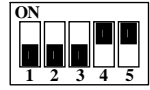

KAT 24

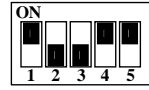

KAT 25

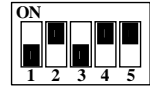

KAT 26

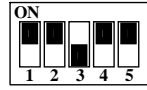

KAT 27



KAT 28

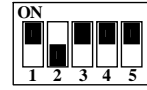

KAT 29

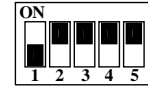

KAT 30

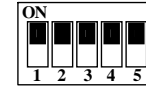

KAT 31

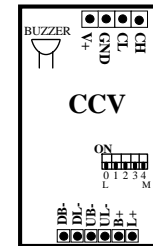
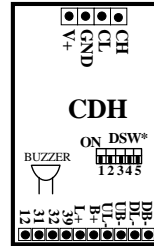
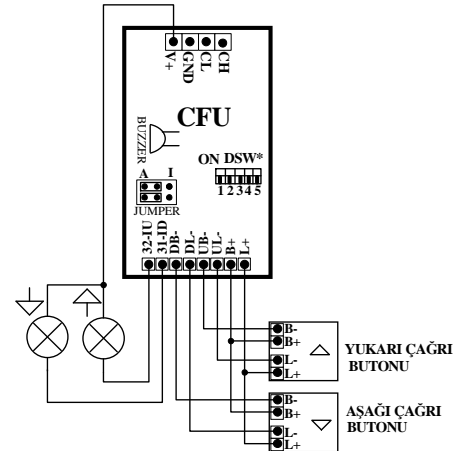
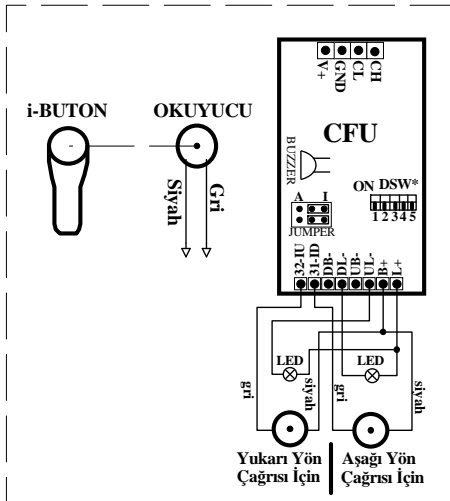

Bu belge uygulamalar için öneri niteliğindedir. Aybey Elektronik bu belgenin içeriğini ve görünümünü önceden haber vermeksizin değiştirmeye hakkına sahiptir. Bu belgedeki hata ve eksiklerden veya uygulamadan kaynaklanabilecek problemlerden Aybey Elektronik sorumlu tutulamaz.

F/7.5.5.02.68
CFU VE CDH KARTLARININ KATLARA GÖRE DİP SVİÇ AYAR KONFIGÜRASYON SEMASI

AYBEY ELEKTRONİK	SERI	ACT	ÇİZİM	M. AKKUŞ
	PROJE	ACT086	ONAY	M. AYBEY
	REV.	00	TARİH	27 KAS 10