



aybey elektronik  
*lift electronics...*



## **BUTONİYER VE GÖSTERGE SİSTEMLERİ** BUTTON AND DISPLAY SYSTEMS

# 02 | KABİN BUTONİYERLERİ CAR OPERATING PANELS



▶ ÖN  
FRONT

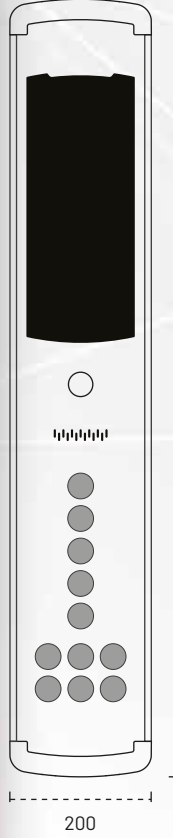

▶ YAN  
SIDE

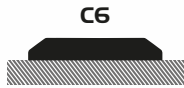
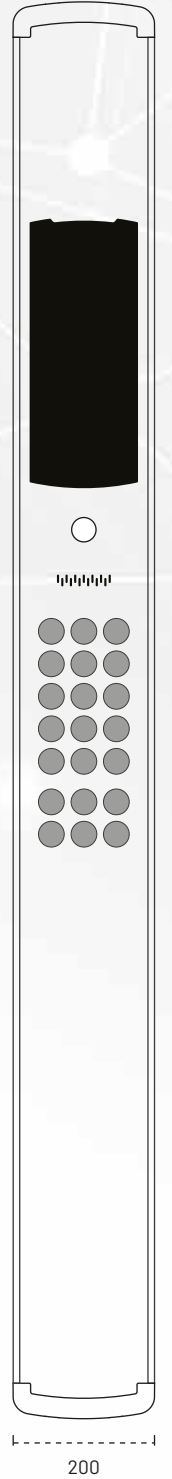

Montaj ▶ Siva Üstü  
Mounting Surface Mount

Ön Panel ▶ Satine Paslanmaz 1 mm  
Front Panel Stainless Steel 1 mm



# ALYA



KST2x62E



KST2x51E



KST2x92B



KST2x52B

▶ ÖN FRONT  
▶ YAN SIDE

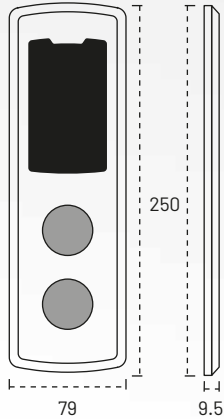

Tüm ölçüler (mm) olarak verilmiştir.  
All dimensions are in (mm).

Montaj ▶ Siva Üstü  
Mounting Surface Mount  
Ön Panel ▶ Satine Paslanmaz 1 mm  
Front Panel Stainless Steel 1 mm



KSLx01



KSL2x92B



KSL5x31



KSL5x41

# LUNA

► ÖN FRONT  
► YAN SIDE  
► ARKA BOX

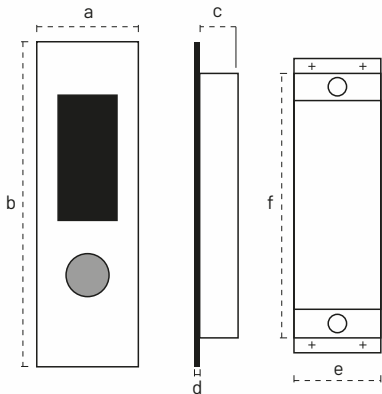

MODEL	a	b	c	d	e	f
KSLx01 KSLx02	90	240	40	2-3	70	180
KSLx31 KSLx41	100	340	40	2-3	80	280
KSLx11, KSLx81 KSLx91	90	320	40	2-3	70	260
KSLx32 KSLx42	100	400	40	2-3	80	340
KSLx12, KSLx82 KSLx92	90	360	40	2-3	70	300

Tüm ölçüler (mm) olarak verilmiştir.  
All dimensions are in (mm).



Montaj ► Ankastr  
Mounting Flush

Ön Panel ► Satine Paslanmaz 2mm  
Front Panel Dekoratif Paslanmaz 3mm  
Hairline Stainless Steel 2mm  
Decorative Stainless Steel 3mm



KSC5x4I



KSC2x92E



KSC1x02



KSC2xy1E

# EVOS



Montaj ▶ Sıva Üstü  
Mounting Surface Mount

Ön Panel ▶ Satine Paslanmaz 0,8 mm  
Front Panel Stainless Steel 0,8 mm

▶ ÖN FRONT  
▶ YAN SIDE

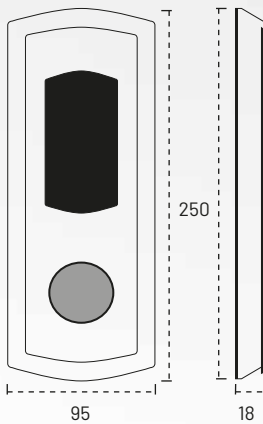

Tüm ölçüler (mm) olarak verilmiştir.  
All dimensions are in (mm).

▶ ÖN FRONT  
▶ YAN SIDE

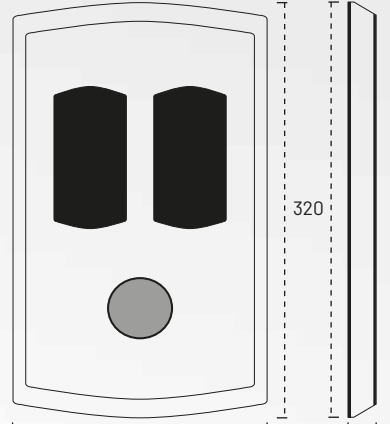

180 320 18

# KVP

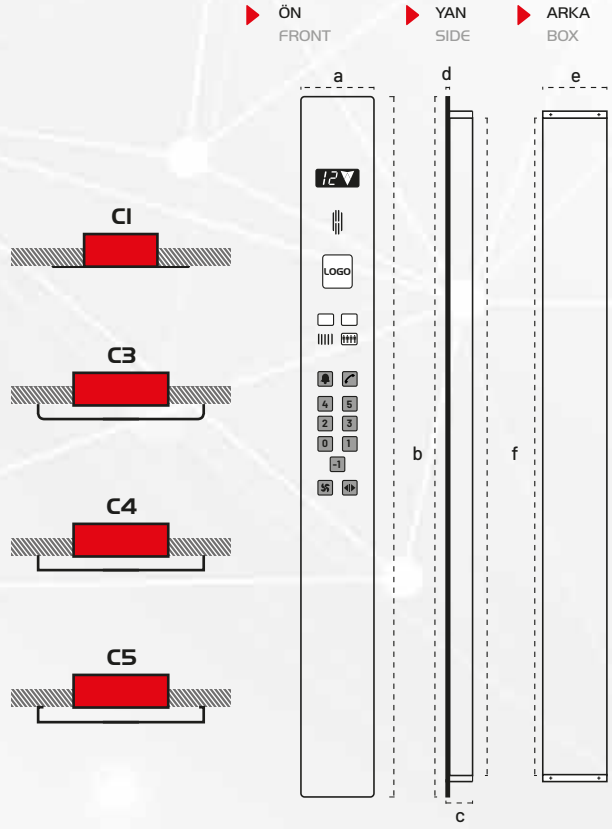

MODEL	a	b	c	d	e	f	Form
KVP22C1	160	1000	55	2-3	135	940	C1
KVP24C1	200	1000	55	2-3	180	940	C1
KVP26C1	260	1000	55	2-3	240	940	C1
KVP52C1	160	2000	55	2-3	135	1940	C1
KVP54C1	200	2000	55	2-3	180	1940	C1
KVP56C1	260	2000	55	2-3	240	1940	C1
KVP54C3	ÖZEL TASARIM CUSTOM DESIGN						C3
KVP54C4	ÖZEL TASARIM CUSTOM DESIGN						C4
KVP54C5	ÖZEL TASARIM CUSTOM DESIGN						C5

Tüm ölçüler (mm) olarak verilmiştir.  
All dimensions are in (mm).

Montaj ▶ Ankastr  
Mounting Flush

Ön Panel ▶ Satine Paslanmaz 2mm, Vidalı  
Front Panel Dekoratif Paslanmaz 3mm, Vidalı  
Hairline Stainless Steel 2mm, Screwed  
Decorative Stainless Steel 3mm, Screwed



# ALYA



GT9520W



GT9520E



GT9550B

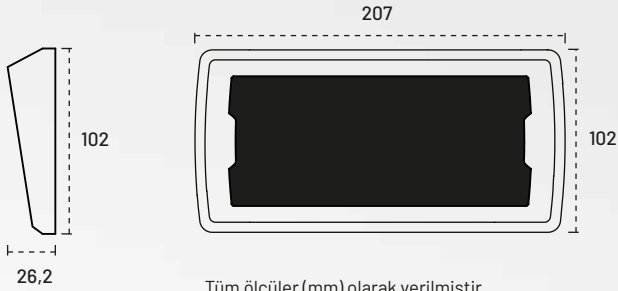

Tüm ölçüler (mm) olarak verilmiştir.  
All dimensions are in (mm).



Montaj ▶ Sıva Üstü  
Mounting ▶ Surface Mount

Ön Panel ▶ Satine Paslanmaz 1 mm  
Front Panel ▶ Stainless Steel 1 mm

## HİZMET YÖN OKLARI HALL LANTERN

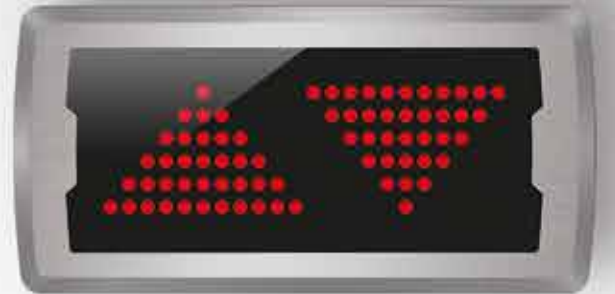

GT9510E

**SIVA ÜSTÜ**  
SURFACE MOUNT



GA9x50E

**GA**

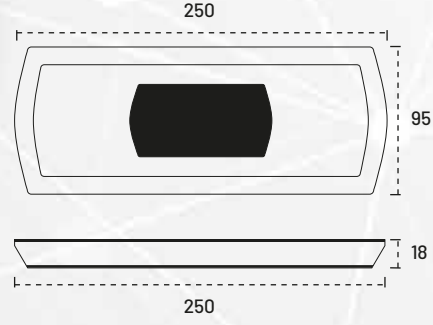

Tüm ölçüler (mm) olarak verilmiştir.  
All dimensions are in (mm).



Montaj ▶ Siva Üstü  
Mounting Surface Mount

Ön Panel ▶ Satine Paslanmaz 0,8 mm  
Front Panel Stainless Steel 0,8 mm

**ANKASTRE**  
FLUSH MOUNT



GP8x40

**GP**

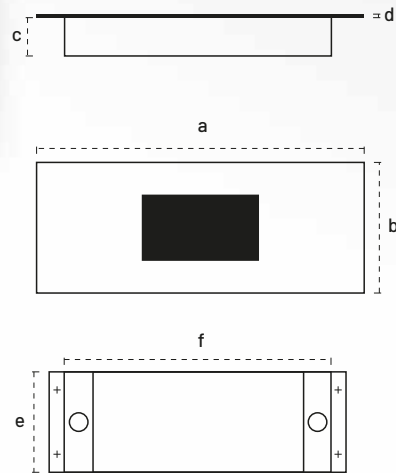

MODEL	a	b	c	d	e	f
GP8x20	320	100	40	2-3	80	260
GP8x40	320	130	40	2-3	110	260
GP8x60	320	130	40	2-3	110	260
GP9020	280	90	40	2-3	70	220
GP9x50	280	90	40	2-3	70	220
GP9x10	360	100	40	2-3	80	300

Tüm ölçüler (mm) olarak verilmiştir.  
All dimensions are in (mm).



Montaj ▶ Ankastre  
Mounting Flush

Ön Panel ▶ Satine Paslanmaz 2mm  
Front Panel Dekoratif Paslanmaz 3mm  
Stainless Steel 2-3mm  
Decorative Stainless Steel 3mm





**SIVA ÜSTÜ**  
SURFACE MOUNT

# GA

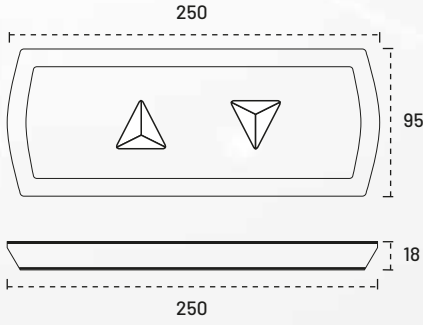

Tüm ölçüler (mm) olarak verilmiştir.  
All dimensions are in (mm).



- Montaj ▶ Siva Üstü  
Mounting Surface Mount
- Ön Panel ▶ Satine Paslanmaz 0,8 mm  
Front Panel Stainless Steel 0,8 mm



GA95IOKY



GA95IOBB

**ANKASTRE**  
FLUSH MOUNT

# GP

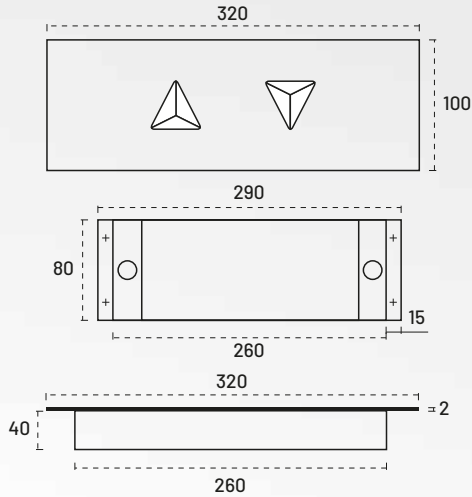

Tüm ölçüler (mm) olarak verilmiştir.  
All dimensions are in (mm).



- Montaj ▶ Ankastr  
Mounting Flush
- Ön Panel ▶ Satine Paslanmaz 2-3mm  
Front Panel Stainless Steel 2-3mm



GP95IOBB

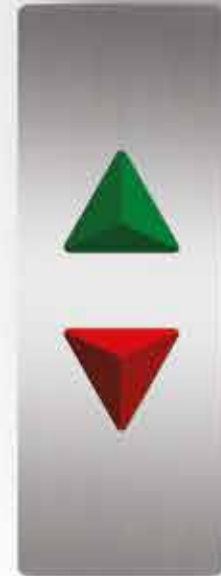

GP95IOKY

# 10 | GÖNDERMELİ KAT BUTONİYERLERİ LANDING PANELS FOR GOOD LIFTS

## KGD

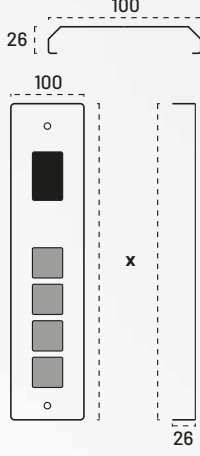

x ▶ Değişebilir  
Varying

Tüm ölçüler (mm) olarak verilmiştir.  
All dimensions are in (mm).

Montaj ▶ Sıva Üstü  
Mounting Surface Mount

Ön Panel ▶ Satine Paslanmaz 1mm, Vidalı  
Front Panel Stainless Steel 1mm, Screwed



KGD2070E



KGD2070E

## YATAY KABİN BUTONİYERLERİ HORIZONTAL CAR OPERATING SYSTEMS



KSD32C95

Montaj ▶ Sıva Üstü  
Mounting Surface Mount

Ön Panel ▶ Satine Paslanmaz 2-3mm, Vidalı  
Front Panel Stainless Steel 2-3mm, Screwed

Tüm ölçüler (mm) olarak verilmiştir.  
All dimensions are in (mm).





## RN SERİSİ BUTONLAR

RN SERIES ROUND BUTTONS



RN 10



RN 03



RN 09



RN 05



RN 06



RN 07



## LN SERİSİ BUTONLAR

LN SERIES SQUARE BUTTONS



LN 01



LN 02



LN 03



LN 04



LN 05



LN 08



## HN SERİSİ BUTONLAR

HN SERIES ROUND BUTTONS



HN 01



HN 02



HN 03



HN 04



HN 05



HN 08



## ALYA SERİSİ BUTONLAR

BUTTONS FOR ALYA SERIES



TS1



TS2



TG1



TG2





## ALAS+

- Asansörün durumunu kabin içinde anons eder
- Kumanda sisteminden durum bilgilerini Sayıcı, Binary/ Gray Kod ve 7 Segment veri şekillerinde alabilme
- Herhangi bir programa ihtiyaç duymayan anons ekleme ve değiştirme kolaylığı
- Dahili SD kart okuyucusu sayesinde kolay dosya ekleme özelliği
- Tüm ses dosyalarını tanıma ve çalıştırma özelliği
- Anons yapmadığı zamanlarda müzik yayını yapma desteği

- Announces the status of the lift inside the cabin
- Can obtain information from the controller about lift status as Counter, Binary/ Gray code or Digital Segment forms
- Easy announce add and change opportunity without requiring any special program
- Audio files can be imported via built-in SD card reader
- Supports all sound file types
- Can play music when not announcing



## ACAS+

- Asansörün durumunu kabin içinde anons eder
- Kumanda sistemi ile CAN veri yolu üzerinden haberleşme
- Herhangi bir programa ihtiyaç duymayan anons ekleme ve değiştirme kolaylığı
- Dahili SD kart okuyucusu sayesinde kolay dosya ekleme özelliği
- Tüm ses dosyalarını tanıma ve çalıştırma özelliği
- Anons yapmadığı zamanlarda müzik yayını yapma desteği

- Announces the status of the lift inside the cabin
- Communicates with the controller via CAN-Bus
- Easy announce add and change opportunity without requiring any special program
- Audio files can be imported via built-in SD card reader
- Supports all sound file types
- Can play music when not announcing

## ERİŞİM KONTROL SİSTEMLERİ ACCESS CONTROL SYSTEM



## MFR

RFID kart ile uygulanan bir erişim kontrol sistemidir. Üzerinde bulunan okuyucu ile kartları okuyarak sistemde tanımlanmış olanlara kullanım izni verir. 500 kullanıcı kapasitelidir.

This access control system uses RFID cards to restrict the use of the lift. It has a register capacity of 500 users (RFID cards).

## PSI

Kullanıcı erişim kontrol sistemi üzerinde bulunan okuyucu ile kullanıcılardaki i-Buttonları okur ve sistemde tanımlanmış olanlara kullanım izni verir. 500 kullanıcı kapasitelidir.

This access control system detects i-Buttons and allows predefined ones to access. Up to 500 users (i-Buttons) can be defined.





## VİDEO OYNATICI VIDEO PLAYER

Renkli ekranda istenilen fotoğraf dizisi gösterilebilir veya video oynatılabilir.

Any photo gallery or video can be displayed on the colour screen.



## İŞIKLI LOGO ILLUMINATED LOGO

Led aydınlatmalı olan bu logo modelinde istenilen her tür yazı ve grafik, yazıcıdan basılarak led panel önüne yerleştirilir. Kuvvetli bir ışık kaynağı olması nedeniyle acil aydınlatma ışığı olarak da kullanılabilir.

This logo type is prepared by printing any desired graphics with a printer and placing it in front of the led panel. As the light source is strong enough it is also used as emergency light.



## KAZIMA LOGO ENGRAVED LOGO

Kazıma logo paslanmaz yüzeyde asit indirme işleminden sonra boyama ile hazırlanır. Metal yüzeyinde derinlik oluşturması grafiğe üç boyutlu bir görünüş kazandırır.

Engraved logo is produced by painting after acid reduction process. The graves produced give a three dimensional view to the graphics.



## BASKI LOGO PRINTED LOGO

En basit ve en ekonomik logo türüdür. Metal yüzeye baskı yoluyla yapılır. Kalıcıdır, kimyasal temizlik maddeleri ile çıkmaz.

It is the easiest and cheapest logo type and done by printing onto the metal surface. It must not be cleaned.



## VATMAN ANAHTARI LIFTMAN KEY

Anahtarın pozisyonuna göre elektriksel olarak açık veya kapalı devre haline gelir. Vatman anahtarı asansörün manuel olarak yönetilmesini sağlar.

The position of the key changes the state of the contact electrically. The liftman key is used to manage the lift manually by a lift attendant.





# 14 | GÖSTERGELER DISPLAYS

GÖSTERGE PRODUCT	BAĞLANTI ARAYÜZÜ INTERFACE	RENK COLOUR	TİP TYPE	GÖRÜNÜM ORIENTATION	BUTON GİRİŞİ CALL BUTTON INPUTS	GÖRÜNÜR ALAN VISIBLE AREA	ÜRÜN ÖLÇÜLERİ OUTER DIMENSIONS
CBC	CAN LS	Mavi Blue	Dot Matrix LCD	Yatay Horizontal	Var Present	120 x 48 mm	150 x 74 mm
CBCT	CAN HS						
CBP	Paralel -7GBC						
CCL-S	CAN LS	Renkli Multicolour	Dot Matrix LCD	Yatay Horizontal	Var Present	117 x 67 mm	158 x 84 mm
CCT	CAN HS						120 x 60 mm
CCL-P	Paralel -7GBC						120 x 60 mm
SYC	CAN LS	Mavi Blue	Dot Matrix LCD	Dikey Vertical	Var Present	49 x 96 mm	70 x 125 mm
SYT	CAN HS						70 x 125 mm
SYP	Paralel -7GBC						70 x 134 mm
CLC	CAN LS	Renkli Multicolour	Dot Matrix LCD	Dikey Vertical	Var Present	55 x 82,5 mm	70 x 124 mm
CLT	CAN HS						70 x 124 mm
CLP	Paralel -7GBC						70 x 121 mm
CCH	CAN LS	Mavi Blue	16 Segment LCD	Yatay Horizontal	Var Present	120 x 48 mm	167 x 70 mm
BCC	Paralel -7						168 x 67 mm
PBH	Paralel -7GBC				166 x 70 mm		
C3D	CAN LS				142 x 73 mm		
CCV	CAN HS	Mavi Blue	16 Segment LCD	Dikey Vertical	Var Present	35 x 86 mm	69 x 104 mm
CLD	Paralel -7						
DMCE	CAN LS	Kırmızı Red	Dot Matrix LED	Dikey Vertical	Var Present	55 x 82,5 mm	64 x 102 mm
DMTE	CAN HS						
DMPE	Paralel -7GBC						
DMCB	CAN LS	Mavi Blue	Dot Matrix LED	Dikey Vertical	Var Present	55 x 82,5 mm	64 x 102 mm
DMTB	CAN HS						
DMPB	Paralel -7GBC						
CDHE	CAN LS	Kırmızı Red	Dot Matrix LED	Yatay Horizontal	Var Present	100 x 50 mm	120 x 62 mm
CDTE	CAN HS						
DD2E	Paralel -7GBC						
CDHB	CAN LS	Mavi Blue	Dot Matrix LED	Yatay Horizontal	Var Present	100 x 50 mm	120 x 62 mm
CDTB	CAN HS						
DD2B	Paralel -7GBC						
HSDE	Paralel - 7	Kırmızı Red	7 Segment LED	Yatay Horizontal	Var Present	100 x 50 mm	120 x 62 mm
HSDB	Paralel - 7	Mavi Blue	7 Segment LED	Yatay Horizontal	Var Present	100 x 50 mm	120 x 62 mm
C7Sx51E	CAN LS	Kırmızı Red	7 Segment LED	Dikey Vertical	Var Present	50 x 100 mm	64 x 127 mm
C7Sx61E							
C7Sx61B	CAN LS	Mavi Blue	7 Segment LED	Dikey Vertical	Var Present	50 x 100 mm	64 x 127 mm
VBD51E / VLD51E	Paralel - 7	Kırmızı Red	7 Segment LED	Dikey Vertical	Var Present	50 x 100 mm	64 x 127 mm
VBD61E / VLD61E							
VBD61B / VLD61B	Paralel - 7	Mavi Blue	7 Segment LED	Dikey Vertical	Var Present	50 x 100 mm	64 x 127 mm
CC7AE	Seri * Serial *	Kırmızı Red	7 Segment LED	Yatay Horizontal	Yok / No	100 x 50 mm	110 x 62 mm
CC7AB	Seri * Serial *	Mavi Blue	7 Segment LED	Yatay Horizontal	Yok / No	100 x 50 mm	110 x 62 mm
B7CE	Seri * Serial *	Kırmızı Red	7 Segment LED	Yatay Horizontal	Yok / No	131 x 86 mm	140 x 100 mm
D75B	Paralel - 7	Mavi Blue	7 Segment LED	Yatay Horizontal	Yok / No	131 x 86 mm	131 x 107 mm
D75E	Paralel - 7	Kırmızı Red	7 Segment LED	Yatay Horizontal	Yok / No	131 x 86 mm	131 x 107 mm
D38B	Paralel - 7	Mavi Blue	7 Segment LED	Yatay Horizontal	Yok / No	100 x 50 mm	90 x 93 mm
D38E	Paralel - 7	Kırmızı Red	7 Segment LED	Yatay Horizontal	Yok / No	100 x 50 mm	90 x 93 mm

(7) 7 Segment LED - 7 Segment LED (G) Gray-Code - Gray Code (B) Binary - Binary (C) Sayıcı - Counter

\* Sadece Aybey kabin kumanda kartlarıyla kullanılır.

\* It can only be used with Aybey car controller boards.



AYBEY  
ELEKTRONİK



CBC / CBCT / CBP

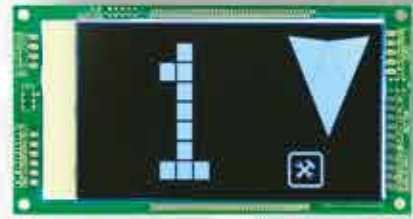

CCL-S / CCT / CCL-P



SYC / SYT / SYP



CLC / CLT / CLP

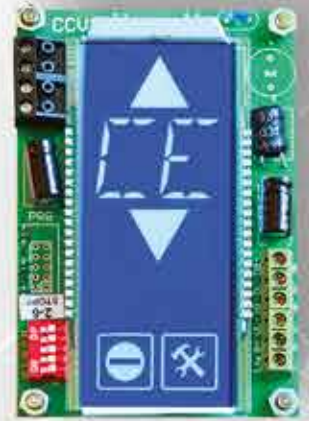

CCV / CLD



HSDx / CC7Ax



DMCx / DMTx / DMPx

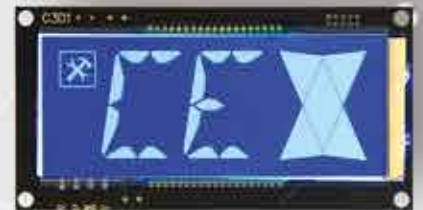

CCH / BCC / PBH / C3D



C75x5IE / VBD5IE / VLD5IE

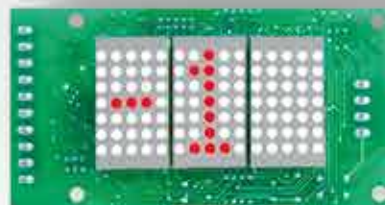

CDHx / CDTx / DD2x



C75x6Ix / VBD6Ix / VLD6Ix



B7CE / D75x

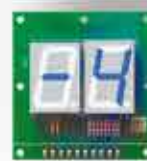

D38x



**AYBEY ELEKTRONİK SANAYİ VE TİCARET A.Ş.**

Sanayi Mh. Hızır Reis Cd. No:26, 34906 Pendik -İstanbul / Turkey  
T: +90 (216) 394 50 55 (pbx) F: +90 (216) 394 50 58 E: sales@aybey.com

[aybey.com](http://aybey.com)

**AYBEY ELEKTRONIK GmbH**

Lothringer Allee 2, 44805 Bochum / Germany  
P: +49 (0) 234 687 368 29 F: +49 (0) 234 687 368 28 E: sales@aybey-elektronik.de

[aybey-elektronik.de](http://aybey-elektronik.de)